

**INSTALLATION INSTRUCTIONS  
DOUBLE DENSITY UPGRADE KIT  
MODEL 503**

Manual Order Number: 121505-002 Rev. B

Additional copies of this manual or other Intel literature may be obtained from:

Literature Department  
Intel Corporation  
3065 Bowers Avenue  
Santa Clara, CA 95051

The information in this document is subject to change without notice.

Intel Corporation makes no warranty of any kind with regard to this material, including, but not limited to, the implied warranties of merchantability and fitness for a particular purpose. Intel Corporation assumes no responsibility for any errors that may appear in this document. Intel Corporation makes no commitment to update nor to keep current the information contained in this document.

Intel Corporation assumes no responsibility for the use of any circuitry other than circuitry embodied in an Intel product. No other circuit patent licenses are implied.

Intel software products are copyrighted by and shall remain the property of Intel Corporation. Use, duplication or disclosure is subject to restrictions stated in Intel's software license, or as defined in ASPR 7-104.9(a)(9).

No part of this document may be copied or reproduced in any form or by any means without the prior written consent of Intel Corporation.

The following are trademarks of Intel Corporation and may be used only to identify Intel products:

|                |                 |             |
|----------------|-----------------|-------------|
| i              | iSBC            | Multimodule |
| ICE            | Library Manager | PROMPT      |
| iCS            | MCS             | Promware    |
| Insite         | Megachassis     | RMX         |
| Intel          | Micromap        | UPI         |
| Intelelevision | Multibus        | µScope      |
| Inteltec       |                 |             |

and the combination of ICE, iCS, iSBC, MCS, or RMX and a numerical suffix.



# PREFACE/CONTENTS

## PREFACE

This manual provides installation instructions for the Model 503 Double Density Upgrade Kit. Related publications are:

*Intellec Series II Microcomputer Development Systems, Models 220, 221, 222 and Models 230, 231, 232, Service Information (Series II Service Manual)*

Manual Order Number 9800878

*Model 240/740 Intellec Series II Hard Disk Drive, Installation*

Manual Order Number 121528

*Hard Disk Subsystem Operating and Checkout Manual*

Manual Order Number 9800943

## CONTENTS

|   |    |
|---|----|
| Major Components of the Model 503 Double Density Upgrade Kit .....  | iv |
| General Installation .....  | 1  |
| Description and Purpose of the Model 503 Double Density Upgrade Kit |    |
| Installation Planning   |    |
| Connecting an External Drive to an Upgraded System                  |    |
| Drive Numbering   |    |
| Summary of the Installation   |    |
| Installation Procedure .....  | 2  |



# MAJOR COMPONENTS OF THE MODEL 503 DOUBLE DENSITY UPGRADE KIT

CHANNEL BOARD

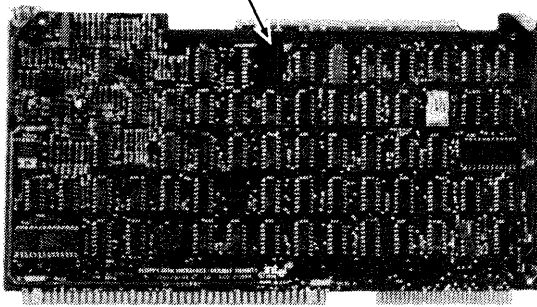

INTERFACE BOARD

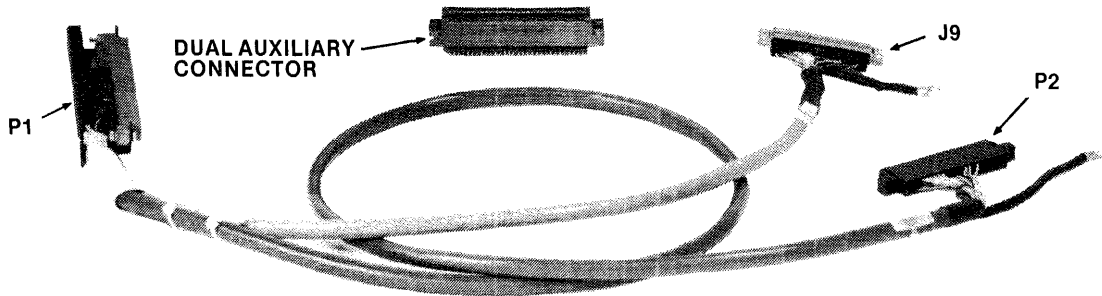
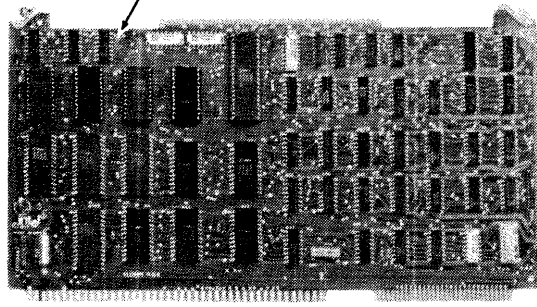

DUAL AUXILIARY  
CONNECTOR

P1

J9

P2

## DESCRIPTION AND PURPOSE OF THE MODEL 503 DOUBLE DENSITY UPGRADE KIT

The Model 503 Double Density Upgrade Kit converts the integral single-density drive of a Model 220 or Model 240 Intellec Series II Microcomputer Development System to double density, thereby doubling its storage capacity.

The Upgrade Kit consists of the following major parts:

- Double Density Controller Boards:
  - Channel Board
  - Interface Board
- Dual Auxiliary Connector
- Double Density Integral Drive Controller Cable

## INSTALLATION PLANNING

There is no significant planning to be completed prior to the installation of the Upgrade Kit in a Model 220 or Model 240 Development System. Note, however, that the installation of an Upgrade Kit in a Model 240 or in a Model 220 to which a Model 740 Hard Disk Subsystem has been added will use all of the card slots in the main chassis of the Development System. A Model 201 Expansion Chassis must then be added to the system to permit the use of an In-Circuit Emulator (ICE) or other Multibus-compatible printed wiring assemblies.

## CONNECTING AN EXTERNAL DRIVE UNIT TO AN UPGRADED SYSTEM

An external Flexible Diskette Drive unit (Model 730, 731, or 732, or Model DDR) can be added to an upgraded Development System by connecting the external drive unit to J9 on the Development System's rear panel. This will provide three double density drives for the upgraded system.

## DRIVE NUMBERING

Flexible diskette drives connected to controller cable (and system) connector J8 are numbered 0 and 1; flexible diskette drives connected to controller cable (and system) connector J9 are numbered 2 and 3. However, adding the upgrade kit to a system uses J8 (a) for the single integral drive, instead of (b) for two drives in an external drive unit. Thus there will be no "drive 1" in an upgraded system. Also, if a hard disk drive is part of the system, the system software automatically increases all drive numbers by 4. Specifically:

1. If the Development System being upgraded is a Model 220, 221, or 222, the integral drive will remain drive 0 after the upgrade. If an external drive is added to the system, its drives become drive 2 and 3. (The drive on the right will be drive 2; the drive on the left, drive 3.) There will be no drive 1.
2. If the system upgraded is a Model 240, or if a Model 740 Hard Disk Drive is added to an upgraded Model 220 System, the integral drive becomes drive 4. If an external drive unit is added to the upgraded system, its drives become drive 6 and 7. There will be no drive 5.

## SUMMARY OF THE INSTALLATION

The installation, which is described in detail on the following pages, may be summarized as follows:

1. Verify system performance before starting the installation.
2. If desired, secure the dual auxiliary connector to the card cage backplane.
3. Install the cables.
4. Install the controller boards.
5. Verify system performance.

If a Model 740 Hard Disk Subsystem is being installed at the same time you are installing the Upgrade Kit, the two installations can be integrated into one as indicated in the detailed procedure.

# INSTALLATION PROCEDURE

*Before you start, read the complete installation procedure and make certain you are sure of each stage in the procedure.*

1. Check the contents of the Upgrade Kit. You should have the parts and materials listed on the checklist included in the kit. Make sure components are seated properly on the controller boards, with no bent pins. Inspect the cables for broken or bent pins in the connectors, broken or frayed wires, and bent or broken lugs. Verify that the address selection switches on the Channel Board are set to 78H and that the interrupt selection switch on the Interface Board is set to position 3 (interrupt level 2). (See figure 1.)
2. If you are upgrading an existing Model 220 or Model 240 Development System, verify its performance by performing the IOC (5-beep) diagnostic, the IPB (Z\$) diagnostic, and the Con-

fidence Test. Repair the system if any error messages are displayed or any test fails.

**NOTE**

Refer to the Intellec Series II service manual for diagnostic/test procedures and for removal and replacement procedures.

3. Turn the Development System off, disconnect it from its ac source and remove the top cover and front card cage cover.
4. Remove the ribbon cable connecting the integral drive to the IOC. (See figure 2.)
5. Remove the rear panel of the Development System.

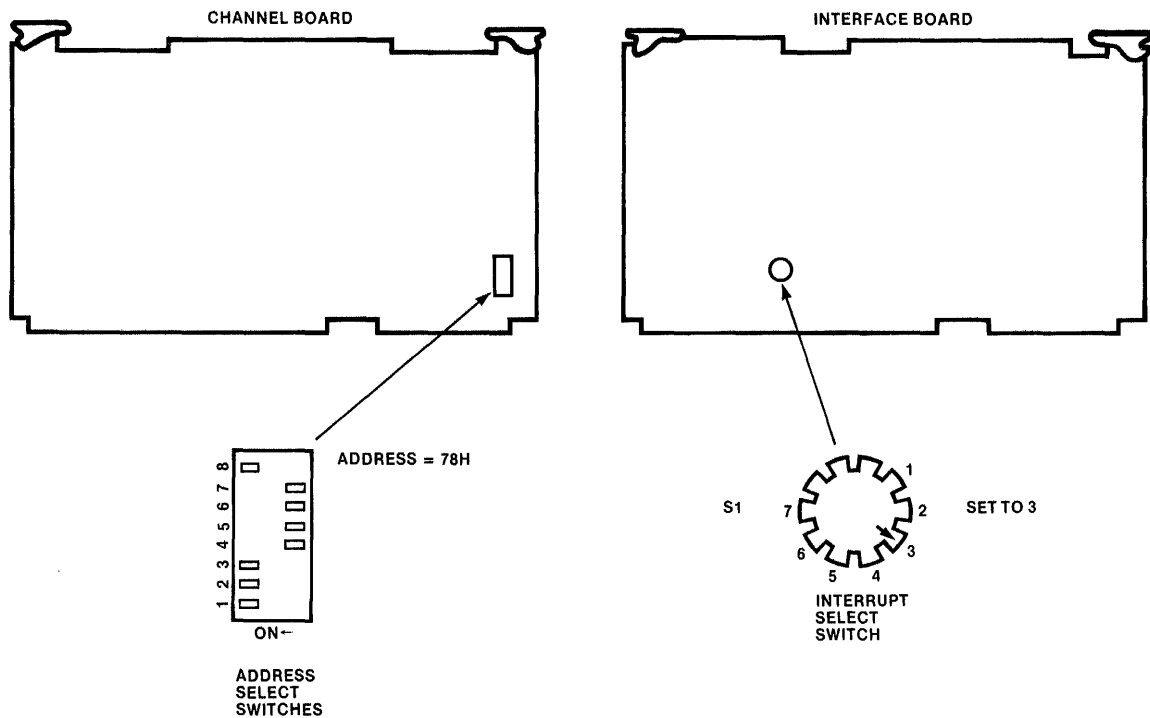
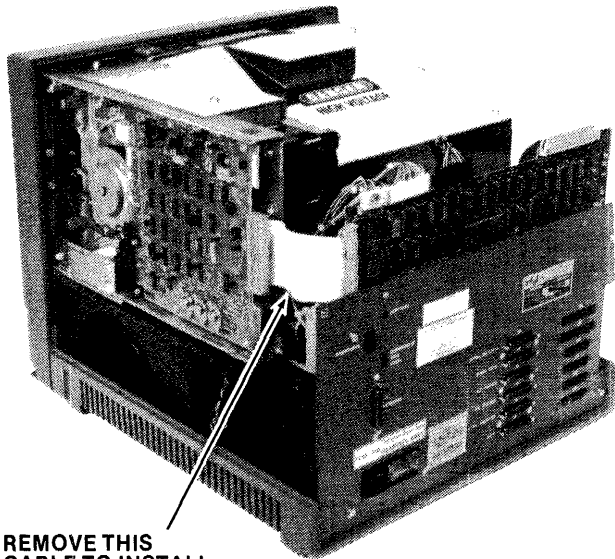

Figure 1. Channel Board and Interface Board Switch Settings

1505-3-1

# INSTALLATION PROCEDURE



REMOVE THIS CABLE TO INSTALL MODEL 503 UPGRADE KIT

1505-3-2

Figure 2. Interior of Development System, Showing Integral Drive Ribbon Cable to be Removed

6. It is recommended that you now mount the dual auxiliary connector adjacent to the J3 and J4 connectors on the cardcage backplane. (See figure 3.) Before you tighten the connector to the backplane, insert the controller boards into the backplane connectors and the dual auxiliary connector to ensure the connectors are aligned properly. This is a lengthy process requiring removal of the Development System's power supply. If you want, you can omit this step and fit the dual auxiliary connector onto the controller boards as the boards are installed in the card cage. (If you are installing the Model 740 Hard Disk Subsystem concurrently with the Upgrade Kit, you may mount its dual auxiliary connector to the backplane at the same time.) It is more convenient to leave the dual auxiliary connector free of the backplane but, if you do, you must remove and insert the two controller boards together, as a set, and not separately.
7. If you are installing the Model 740 Hard Disk Subsystem concurrently with the Upgrade Kit, mount the hard disk controller cable's connectors to holes J10, J11 and J13 of the rear panel.

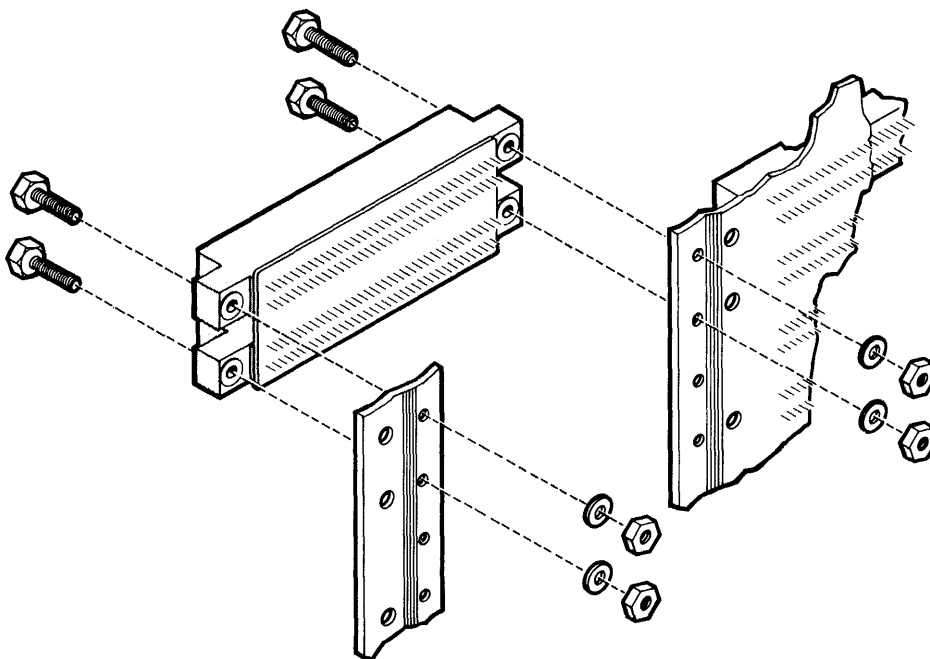

Figure 3. Dual Auxiliary Connector Mounting to Backplane

1505-0-1

# INSTALLATION PROCEDURE

8. Fasten J9 of the controller cable to the J9 hole in the rear panel. (See figure 4. If you are installing the Upgrade Kit in a system with a Hard Disk Drive, refer to figure 5 for the connector placement.) Secure the ground straps under the washer around the bolt holding J9 to the panel or, if a ground lug is available, to the ground lug.
9. If you are installing the Upgrade Kit in a system with a Hard Disk Drive, stick a tie-wrap pad on the inside of the end bracket of the power supply. (See Figure 5.)

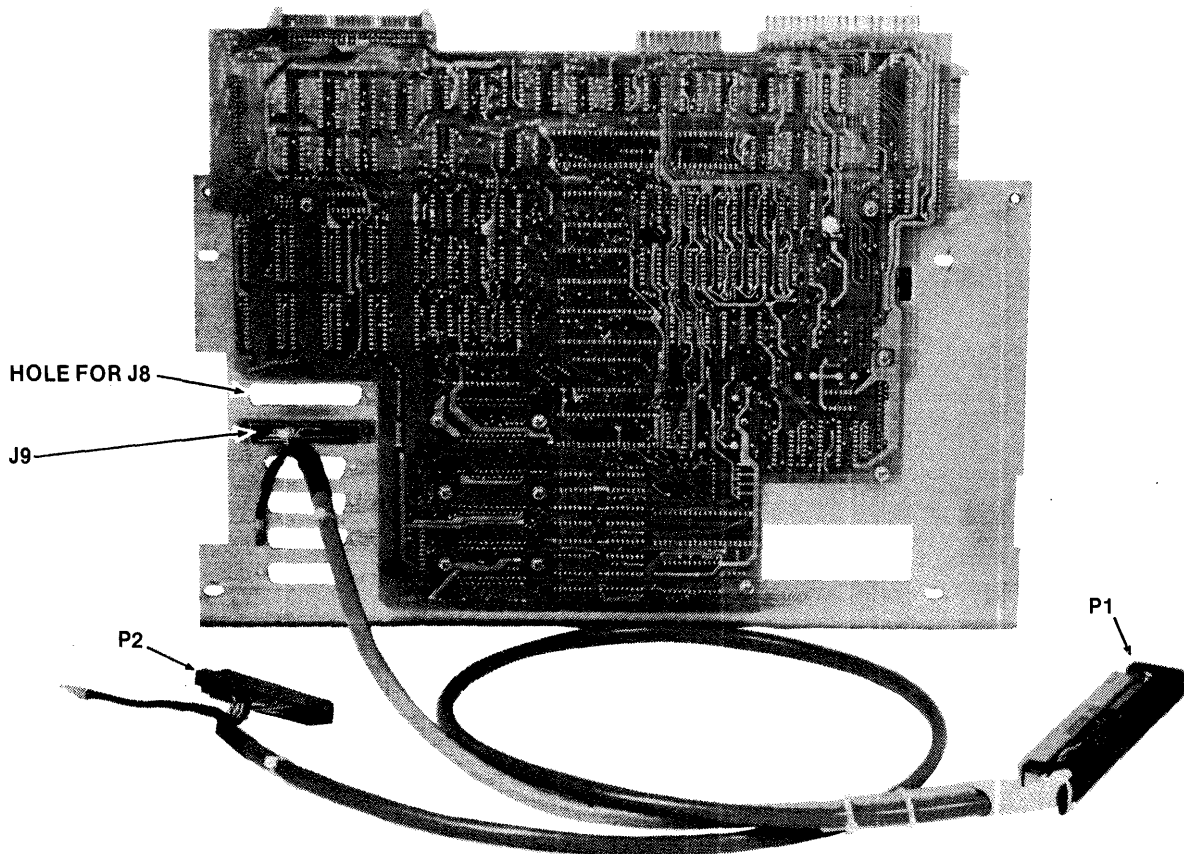
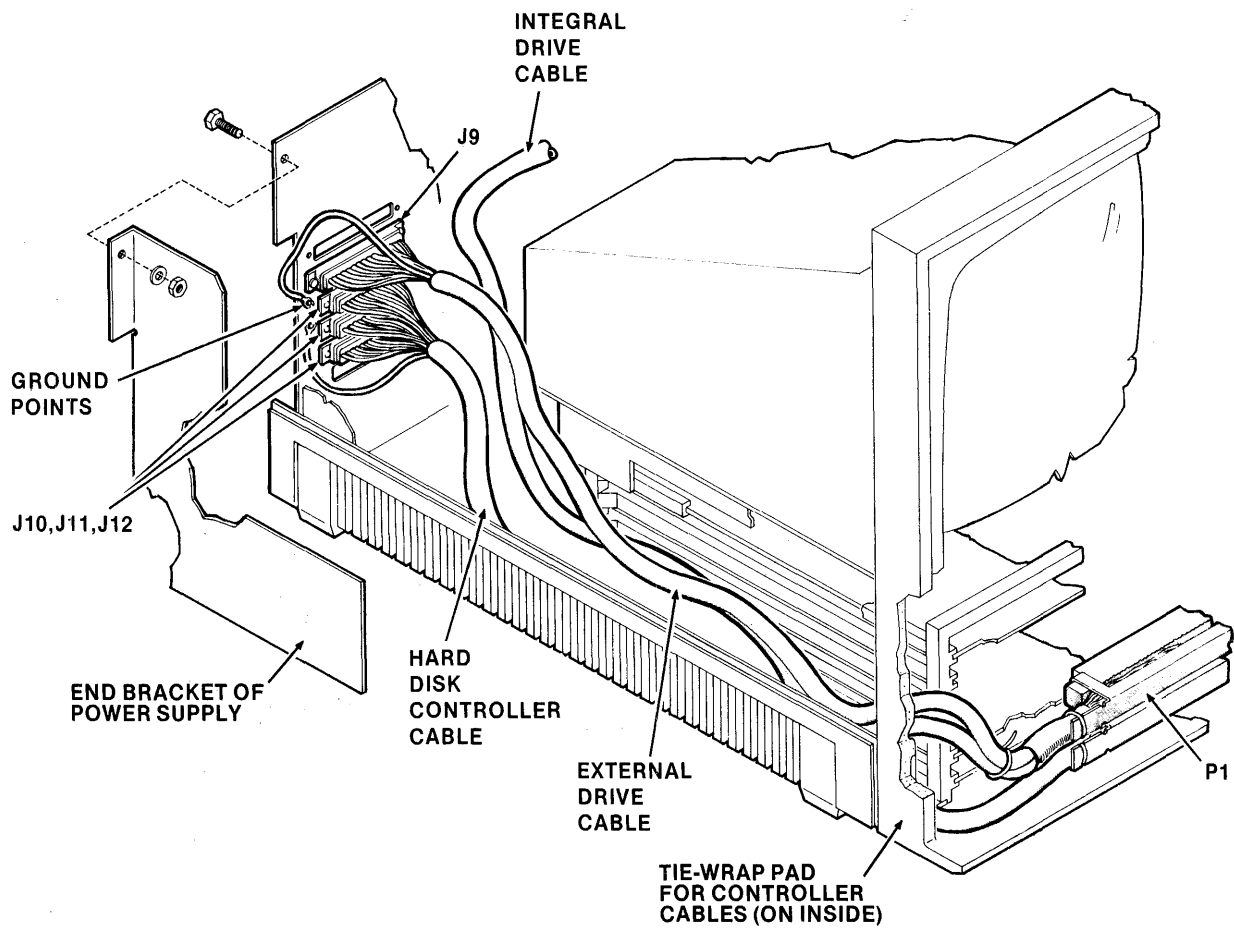

Figure 4. Controller Cable and Integral Drive Cable Connected to Rear Panel



# INSTALLATION PROCEDURE



NOTE: Hard Disk Controller Cable may not be present.

Figure 5. Cable Routing

# INSTALLATION PROCEDURE

10. Re-mount the rear panel, feeding P1 of the double density controller cable (and the hard disk controller cable, if there) through the power supply and along the side of the card cage. Feed P2 of the double density controller cable through the power supply, pulling it up and across the rear of the CRT assembly, toward the integral drive. (See figures 6 and 7. Note there are two different types of power supplies used in the Development System. If you are installing the Upgrade Kit in a system with a Hard Disk Drive, see figure 5 for cable routing.)
11. Connect P2 of the double density controller cable to the drive's control/signal connector, with pin 1 of the connector down. Check figure 8 for the proper orientation of the connector. Secure the connector to the drive control board with tie wraps passed through the holes in the connector and holes in the board that are close to the connector.
12. If the system has a Xentek power supply, put a caterpillar grommet on the edge of the end bracket of the power supply to protect the integral drive cable.
13. Secure a stick-on tie wrap pad to the side of the power supply as shown in figure 6 or figure 7 depending upon which type of power supply is used in your system. Tie the cables to keep them away from the transformer in the power supply. Check Figure 5 and Figures 6 and 7, and use additional tie wraps as required. If you are installing the Upgrade Kit in a system with a Hard Disk Drive, secure both controller cables to the tie-wrap pad stuck to the inside of the power supply bracket in step 9. (See Figure 5.)

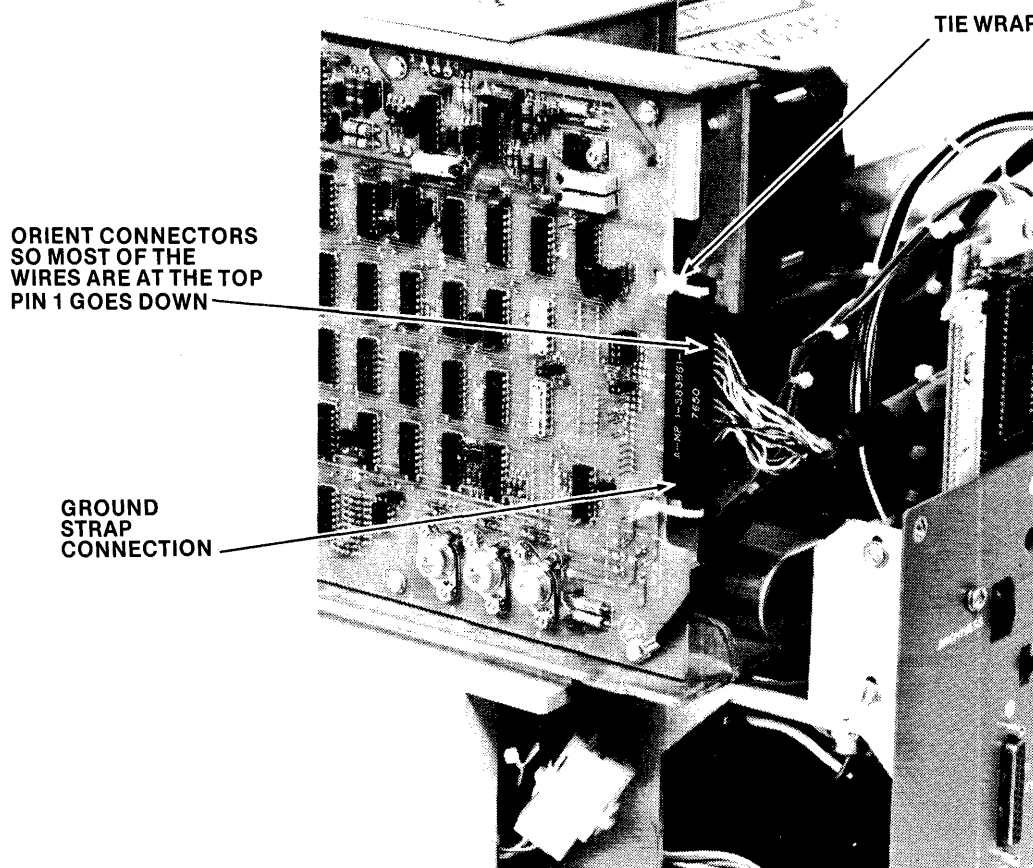

Figure 8. Integral Drive Cable Connector orientation

80-012

# INSTALLATION PROCEDURE

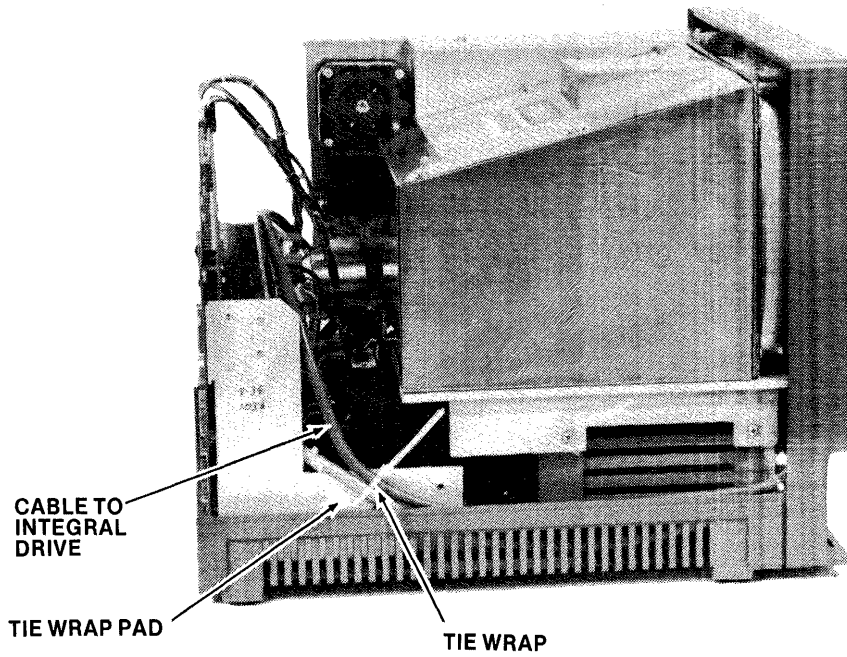

Figure 6. Path for Resulting Cable Through Power-1 Power Supply

80-001

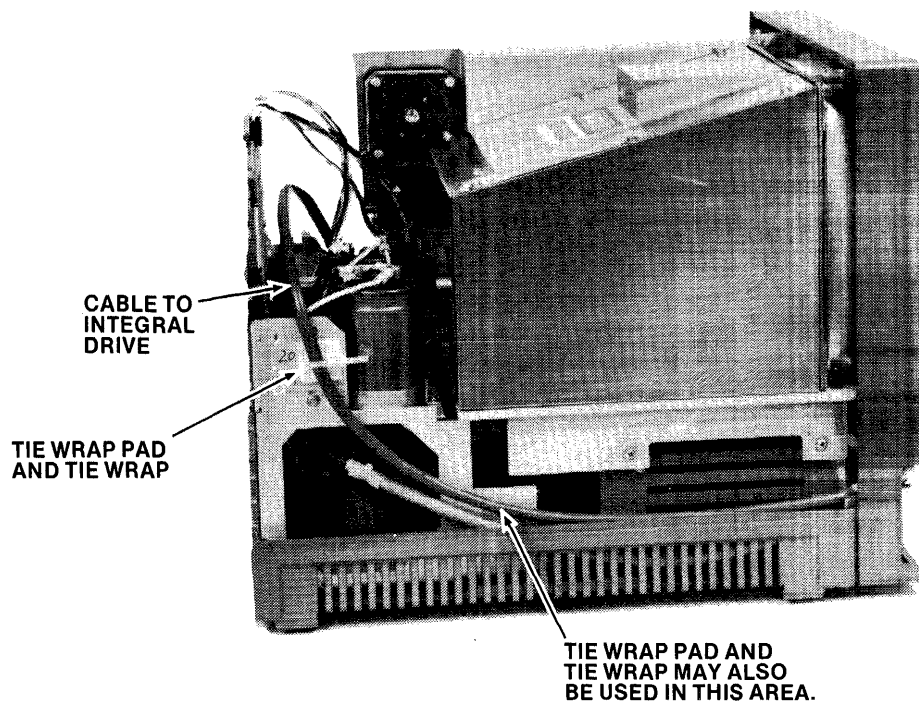

Figure 7. Path for Routing Cable Through Xentek Power Supply

80-002

# INSTALLATION PROCEDURE

14. Using the wraps, tie the double density controller cable to the cable from IOC J16 and to the cable from IOC J15. (See figure 9.)
15. Stick a tie-wrap pad on the front inside of the chassis, by the card cage, and use it to secure the floppy-disk controller cable and (if present) the hard disk controller cable so the controller board front edge connectors cannot work loose. (See Figure 5.)
16. Insert the controller channel board and the controller interface board into the card cage. (See figure 10.) If you did not secure the dual auxiliary connector to the backplane of the card cage, fit it onto the two controller boards and insert them together.
17. Place P1 of the double density controller cable on the front-edge connector of the interface board. (See figure 10.) If you are installing a Model 740 Hard Disk Subsystem concurrently with the Upgrade Kit, install the hard disk controller boards in J5 and J6 of the card cage.
18. Replace the top cover and the card cage cover.
19. Re-connect the development system to the ac source, and verify the upgrade by performing the IOC (5-beep) diagnostic, the IPB (Z\$) diagnostic, and the Confidence Test. Since the integral drive is now a double-density drive, you must use the Double-Density Confidence Test diskette supplied with the kit.

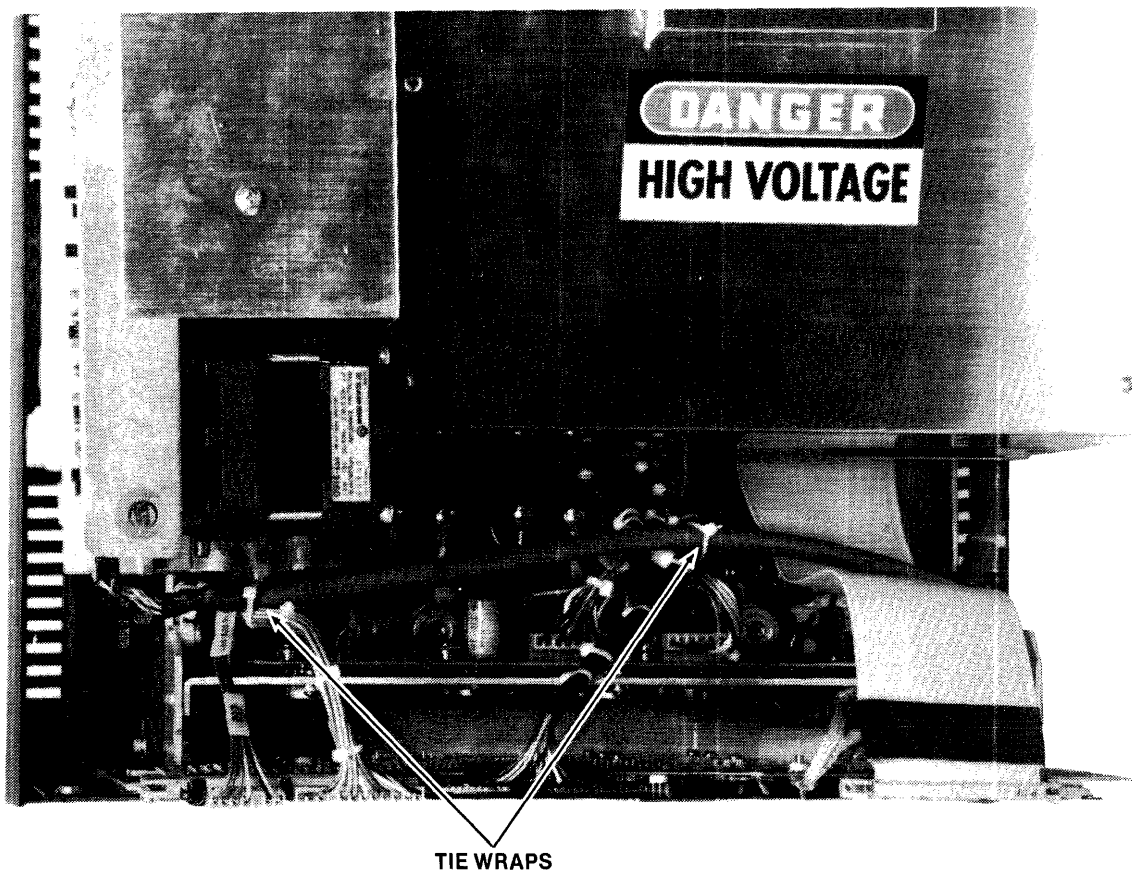

Figure 9. Top View of Development System Showing Tie Wrap Locations

1505-3-8

# INSTALLATION PROCEDURE

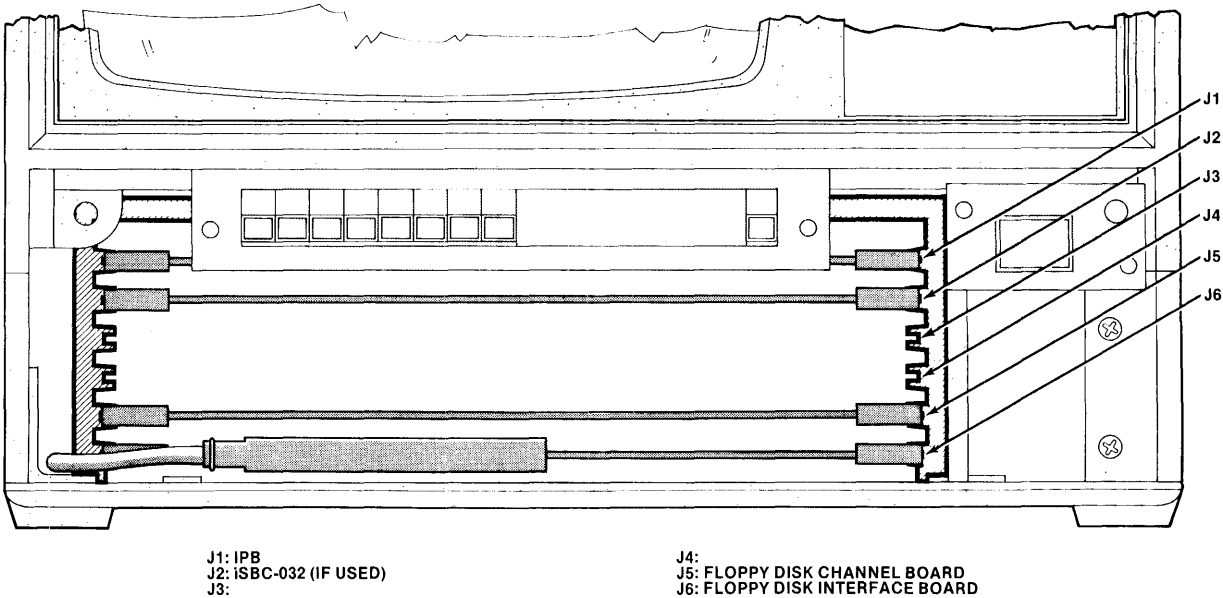

Figure 10A. Card Placement in Absence of Hard Disk Controller Boards

1505-3-9

**Note:** Controller boards are shown in preferred orientation, with interface board installed below channel board. System will operate with interface board installed above channel board.

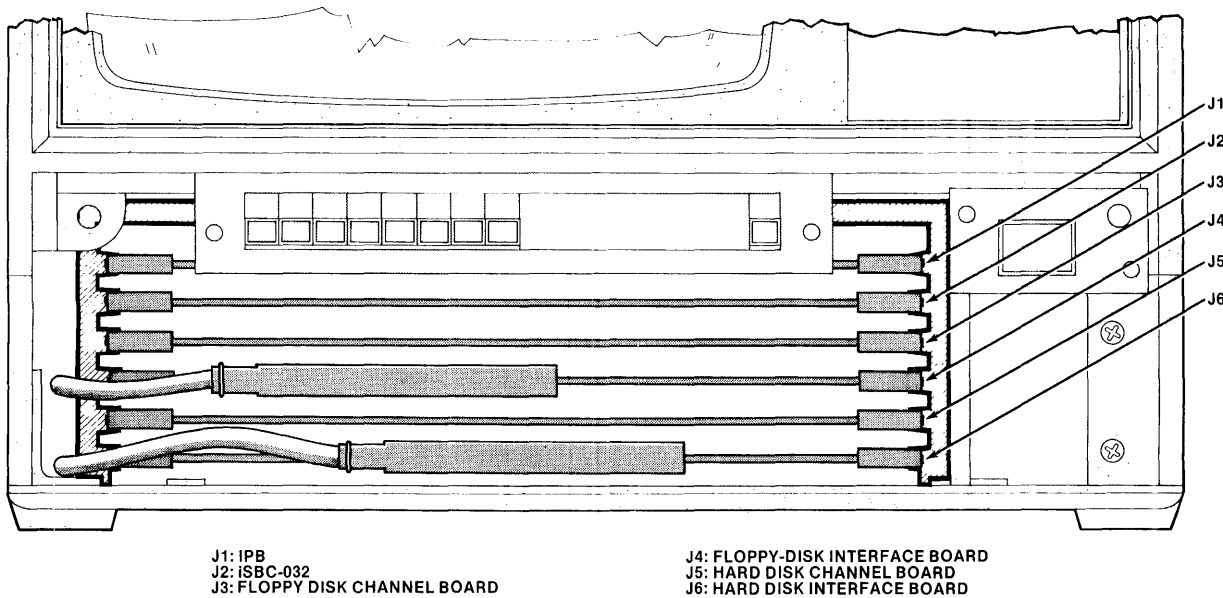

Figure 10B. Card Placement With Hard Disk Controller Boards

1505-3-10



## SERVICE AND REPAIR ASSISTANCE

The best service for your Intel product will be provided by an Intel Customer Engineer. These trained professionals will provide prompt, efficient on-site installation, preventive maintenance, or corrective maintenance services that will keep your equipment in the best possible operating condition.

Your Intel Customer Engineer can provide the service you need through a prepaid service contract or on an hourly-charge basis. For further information, contact your local Intel office.

When it is impossible for you to use the services of an Intel Customer Engineer or when Intel service is not available in your local area, you may contact the Intel Service Center directly, at one of the following numbers:

**Telephone:**

From Alaska or Hawaii call—  
(602) 869-4600

From locations within Arizona call—  
(602) 869-4600

From all other U.S. locations call toll free—  
(800) 528-0595

TWX: 910-951-1330

Never return equipment to Intel for service or repair before you contact an Intel Customer Engineer or the Intel Service Center.

If return of your equipment is necessary, you will be given a Repair Authorization Number, shipping instructions, and other important information that will help Intel provide you with fast, efficient service. If the product is being returned because of damage sustained during shipment, or if the product is out of warranty, a purchase order is necessary in order for the Intel Service Center to make the repair.

When preparing the product for shipment to the Service Center, use the original factory packaging material, if available. If the original packaging is not available, wrap the product in a cushioning material such as Air Cap TH-240, manufactured by the Sealed Air Corporation, Hawthorne, N.J. (or equivalent) and enclose in a heavy-duty corrugated shipping carton. Seal the carton securely, mark it "FRAGILE" to ensure careful handling, and ship it to the address specified by the Intel Service Center.

**NOTE**

Customers outside of the United States should contact their sales source (Intel Sales Office or Authorized Intel Distributor) for directions on obtaining service or repair assistance.



## U.S. AND CANADIAN OFFICES

### ALABAMA

Intel Corp.  
3322 S. Parkway, Ste. 71  
Holiday Office Center  
Huntsville 353802  
Tel: (205) 883-2430

### ARIZONA

Intel Corp.  
8650 N. 35th Avenue, Suite 101  
Phoenix 85021  
Tel: (602) 242-7205

### CALIFORNIA

Intel Corp.  
7670 Opportunity Rd.  
Suite 135  
San Diego 92111  
Tel: (714) 268-3563

Intel Corp.\*  
1651 East 4th Street  
Suite 105  
Santa Ana 92701  
Tel: (714) 835-9642

Intel Corp.\*  
15335 Morrison  
Suite 345  
Sherman Oaks 91403  
Tel: (213) 986-9510  
TWX: 910-495-2045

Intel Corp.\*  
3375 Scott Blvd.  
Santa Clara 95051  
Tel: (408) 987-8086  
TWX: 910-339-9279  
TWX: 910-338-0255

### COLORADO

Intel Corp.\*  
6000 East Evans Ave.  
Bldg. 1, Suite 260  
Denver 80222  
Tel: (303) 758-8086  
TWX: 910-931-2289

### CONNECTICUT

Intel Corp.  
Peacock Alley  
1 Padanaram Road, Guide 146  
Danbury 06810  
Tel: (203) 792-8365  
TWX: 710-456-1199

### FLORIDA

Intel Corp.  
1001 N.W. 62nd Street, Suite 406  
Ft. Lauderdale 33309  
Tel: (305) 771-0600  
TWX: 510-956-9407

Intel Corp.  
5151 Adanson Street, Suite 203  
Orlando 32804  
Tel: (305) 628-2393  
TWX: 810-853-9219

### ILLINOIS

Intel Corp.\*  
900 Jorie Boulevard  
Suite 220  
Oakbrook 60521  
Tel: (312) 325-9510  
TWX: 910-651-5881

### MARYLAND

Intel Corp.\*  
7257 Parkway Drive  
Hanover 21076  
Tel: (301) 796-7500  
TWX: 710-862-1944

### MASSACHUSETTS

Intel Corp.\*  
187 Billerica Road, Suite 14A  
Chelmsford 01824  
Tel: (617) 667-8126  
TWX: 710-343-6333

### MICHIGAN

Intel Corp.  
26500 Northwestern Hwy.  
Suite 401  
Southfield 48075  
Tel: (313) 353-0920  
TWX: 910-420-1212  
TELEX: 2 31143

### MINNESOTA

Intel Corp.  
8200 Normandale Avenue  
Suite 422  
Bloomington 55437  
Tel: (612) 835-6722  
TWX: 910-576-2867

### NEW JERSEY

Intel Corp.  
1 Metroplaza Office Bldg.  
505 Thornall St.  
Edison 08817  
Tel: (201) 494-5040  
TWX: 710-480-6238

### NEW YORK

Intel Corp.\*  
350 Vanderbilt Motor Pkwy.  
Suite 402  
Hauppauge 11787  
Tel: (516) 231-3300  
TWX: 510-227-6236

Intel Corp.  
80 Washington St.  
Poughkeepsie 12601  
Tel: (914) 473-2303  
TWX: 510-248-0060

Intel Corp.  
474 Thurston Road  
Rochester, N.Y. 14619  
Tel: (716) 328-7340  
TWX: 510-253-3841

### OHIO

Intel Corp.\*  
8312 North Main Street  
Dayton 45415  
Tel: (513) 890-5350  
TELEX: 810-450-2528

Intel Corp.\*  
Chagrin-Brainard Bldg. #201  
28001 Chagrin Blvd.  
Cleveland 44122  
Tel: (216) 464-2736

### PENNSYLVANIA

Intel Corp.\*  
275 Commerce Dr.  
200 Office Center  
Suite 212  
Fort Washington 19034  
Tel: (215) 542-9444  
TWX: 510-661-2077

### TEXAS

Intel Corp.\*  
2925 L.B.J. Freeway  
Suite 175  
Dallas 75234  
Tel: (214) 241-9521  
TWX: 910-860-5487

Intel Corp.\*  
6776 S.W. Freeway  
Suite 550  
Houston 77074  
Tel: (713) 784-3400

### WASHINGTON

Intel Corp.  
300 120th Avenue N.E.  
Bldg. 2, Suite 202  
Bellevue 98005  
Tel: (206) 453-8086

### WISCONSIN

Intel Corp.  
4369 S. Howell Ave.  
Milwaukee 53207  
Tel: (414) 747-0789

### CANADA

Intel Corp.  
Suite 223, Bell Mews  
39 Highway 7, Bell Corners  
Ottawa, Ontario K2H 8P2  
Tel: (613) 829-9714  
TELEX: 053-4419

\*Field application location







## REQUEST FOR READER'S COMMENTS

The Microcomputer Division Technical Publications Department attempts to provide documents that meet the needs of all Intel product users. This form lets you participate directly in the documentation process.

Please restrict your comments to the usability, accuracy, readability, organization, and completeness of this document.

1. Please specify by page any errors you found in this manual.

---

---

---

---

---

---

2. Does the document cover the information you expected or required? Please make suggestions for improvement.

---

---

---

---

---

---

3. Is this the right type of document for your needs? Is it at the right level? What other types of documents are needed?

---

---

---

---

---

---

4. Did you have any difficulty understanding descriptions or wording? Where?

---

---

---

---

---

---

5. Please rate this document on a scale of 1 to 10 with 10 being the best rating. \_\_\_\_\_

NAME \_\_\_\_\_ DATE \_\_\_\_\_

TITLE \_\_\_\_\_

COMPANY NAME/DEPARTMENT \_\_\_\_\_

ADDRESS \_\_\_\_\_

CITY \_\_\_\_\_ STATE \_\_\_\_\_ ZIP CODE \_\_\_\_\_

Please check here if you require a written reply.

**WE'D LIKE YOUR COMMENTS ...**

This document is one of a series describing Intel products. Your comments on the back of this form will help us produce better manuals. Each reply will be carefully reviewed by the responsible person. All comments and suggestions become the property of Intel Corporation.



NO POSTAGE  
NECESSARY  
IF MAILED  
IN U.S.A.



**BUSINESS REPLY MAIL**  
FIRST CLASS PERMIT NO. 1040 SANTA CLARA, CA

POSTAGE WILL BE PAID BY ADDRESSEE

Intel Corporation  
Attn: Technical Publications M/S 6-2000  
3065 Bowers Avenue  
Santa Clara, CA 95051





INTEL CORPORATION, 3065 Bowers Avenue, Santa Clara, California 95051 (408) 987-8080

Printed in U.S.A.